



Property Risk Consulting Guidelines

XL Risk Consulting

A Publication of AXA XL Risk Consulting

PRC.2.0.9

EARTHQUAKE DESIGN OF BUILDINGS

INTRODUCTION

Buildings in many areas of the world are susceptible to damage from moderate to severe earthquakes. Earthquake resistant design allows the facility to withstand an earthquake. Existing building codes in well known earthquake prone areas contain design parameters based upon ground acceleration, the structure's fundamental period, a response modification factor and the foundation soil type. Some modern construction designs also incorporate features to equalize vertical as well as horizontal ground motion. Earthquake preparedness consists of measures to reduce damage and mitigate loss. *OVERVIEW* (PRC.1.7.0) contains applicable information on preparedness. Property Risk Consulting Guideline PRC.15.2 contains pertinent background information on earthquake. In addition, Steinbrugge in his book *Earthquake, Volcanoes, And Tsunamis* provides good background on this topic.

Shaking is the principal cause of earthquake damage. Shaking results from vibrations originating at the source of the earthquake. Building "shake damage" occurs when shaking breaks apart weak and loosely connected structures. Good structural performance is the result of good ductility, good energy absorption characteristics and rigid load paths. Steel frame buildings can be ductile and provide firm load paths. Tilt-up panel wall sections fall out because the wall-to-roof connection fails. Unreinforced masonry construction (URM) typically performs poorly in earthquakes because of aged mortar and lack of well-fastened and continuous load paths.

POSITION

Provide earthquake resistant design for new construction in accordance with local building design standards.¹ Have a licensed structural engineer perform structural or seismic review of existing structures located in ATC earthquake zones 3, 4, 5, 6 or 7.

When using any of the design standards, use the highest Risk Category, Working Life, or equivalent when designing essential buildings or structures. Buildings and structures that are considered important use a medium Risk Category, Working Life, or equivalent when designing the buildings or structures. Buildings and structures that are not in the highest or medium category use a low Risk Category, Working Life, or equivalent when designing the building or structure.

The following occupancies are considered highest Risk Category (IV) occupancy:

- Buildings and other structures designated as essential facilities such as hospitals and other health care facilities, power generating stations, public utilities, aviation control towers and centers, emergency aircraft hangers, and buildings that have critical national defense functions.

- Structures such as communication towers, fuel storage tanks, cooling towers, electrical substation structures, and water storage for fire-suppression equipment.
- Buildings and other structures, which would cause a substantial economic impact or disruption.
- Buildings and other structures, the failure of which could pose a substantial hazard to the community.
- Buildings and other structures that manufacture, process, handle, store, or use hazardous substances such as hazardous fuels, hazardous chemicals, or hazardous waste.
- Buildings and other structures that contain sufficient quantities of highly toxic substances.
- Building and structures that are critical to production or where there is interdependency with other facilities.
- Buildings and other structures required to maintain the functionality of the facility (boiler plants, water treatment facilities, warehouses storing dies and spare parts, etc.).
- Buildings and structures with high occupancy loads.

The following occupancies are considered medium Risk Category (II) occupancies:

- Building and structures that, if damaged, will not disrupt production.
- Office buildings where the occupants could work remotely if the building is damaged AND production is not disrupted.
- Warehouse buildings that are store noncritical products.

The following occupancies are considered low Risk Category (I) occupancies:

- Temporary facilities (erected for less than 60 days).
- Minor storage facilities.

Retrofit existing essential and important buildings to resist earthquake. Apply basic construction techniques to improve structural resistance to meet current earthquake standards. Examine existing building or structure to establish construction type and design, completeness of construction and present condition. Highlight fundamental features affected by earthquake forces. For example:

- Date of construction
- Building height
- Construction materials
- Symmetry of plan (shape of footprint)
- Structural frame type
- Ground or soil conditions

For unreinforced masonry (URM) buildings, check for signs of deterioration and building stress indicating the need for a more detailed evaluation. The signs of deterioration include:

- Broken stucco
- Eroded or easily scraped mortar
- Diagonal cracking on walls
- Cracked or broken cladding, cornices and parapets,
- Floor-to-wall separations
- Cracked, warped or dry rot wood members.

Examine stacks, chimney, signs, tanks and roof-mounted equipment for stability.

Conduct a nonstructural review of the facility. Anchor nonstructural components to improve stability to prevent collapse, tipping, sliding or toppling. See PRC.2.0.9.1 for further details.

DISCUSSION

Structural Elements

Structural elements, which hold the building together and resist loads, include columns, beams, floors, roofs, loadbearing walls and foundations.

Several types of building structural systems are shown in Figures 1 through 3 and 5 through 7. Figure 1 is a typical URM construction. Note that load paths are not rigidly fastened and bearing walls are not reinforced. Aged lime mortar may weaken shear resistance, and the flexibility of the roof and floor diaphragms tends to further weaken the structure. Figure 2 is a tilt-up wall panel design. Note the roof diaphragm is stiffened. Principal weakness occurs with the wall panel fastening to the roof or column. Figure 3 is a steel frame with core shear wall structure. This design can be made very rigid yet retain the ductility of steel beams and columns. Additionally, bracing can be added (see Figure 4) for retrofit earthquake resistance. Figure 5 is a reinforced concrete frame design which results in a very rigid structure and infill areas that can be used for retrofit shear wall strengthening. Figure 6 is a building of light metal construction. The tie rod X bracing is clearly evident.

Nonstructural elements, comprising the rest of the building, and fixtures include interior partition walls, false ceilings, glass, interior furnishings, equipment and piping systems such as sprinklers.

Building height, as well as the size and shape configuration (regular vs. irregular), is illustrated in Figure 7. These are as important as the actual construction features in establishing priorities for repairing or reinforcing. Date of construction shows age and potential for deterioration as well as probable building code design.

Design Criteria

The construction code effective at the time of construction will identify the earthquake design parameters inherent in the structure. Code improvements were made with successive revised versions of codes. A variety of local, city, state, regional and national building codes exist. Not all of these codes address earthquake design in a like manner.

Use and occupancy of a building now and also at the time of construction is important. For example, 1973 revisions to California legislation required "critical" structures such as hospitals to withstand an earthquake and also be able to continue to function. The nonstructural building elements of a critical structure receive as much attention as the structural elements. Commercial structures need only resist collapse.

The structural system should meet design criteria that provide for sufficient strength and ductility to resist earthquake. Deviating from the construction plans will alter the structure's expected response to earthquake forces. The most suitable design consists of a balanced symmetry plan with no irregular geometry configurations, no vertical irregularities and no breaks in support and load paths. All connections, such as roof-to-wall ties, floor-to-wall connectors, wall-to-foundation anchors and beam-to-column bolt/rivet or weld, should be in place and in good condition. Nonstructural building components, such as parapets, canopies, chimneys, ceiling systems, partitions walls and veneer, should also be secured.

Roof/floor span systems:

1. wood post and beam (heavy timber)
2. wood post, beam and joist (mill construction)
3. wood truss – pitch and curve

Roof/floor diaphragms:

4. diagonal sheathing
5. straight sheathing

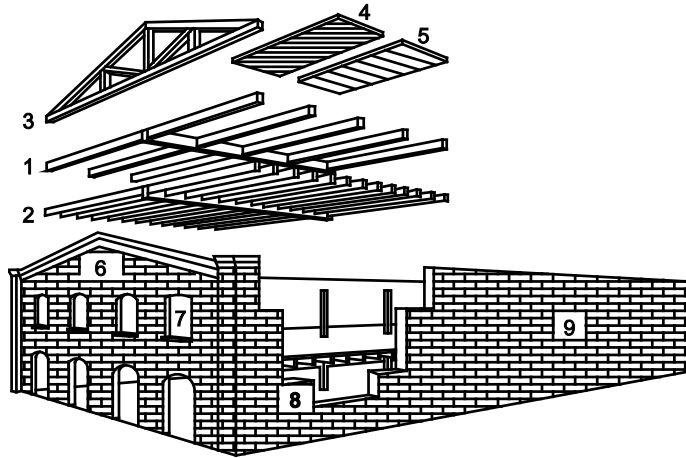

Details:

6. flat unbraced parapet and cornice
7. flat arch window openings

Wall systems:

8. bearing wall – four or more wythes of brick
9. typical long solid party wall

Figure 1. Unreinforced Masonry Bearing Wall.

(Federal Emergency Management Agency Publication FEMA 154, March 2002, Rapid Visual Screening of Buildings for Potential Seismic Hazards.)

Roof/floor span systems:

1. glue laminated beam and joist
2. wood truss
3. light steel –web joist

Roof/floor diaphragms:

4. plywood sheathing

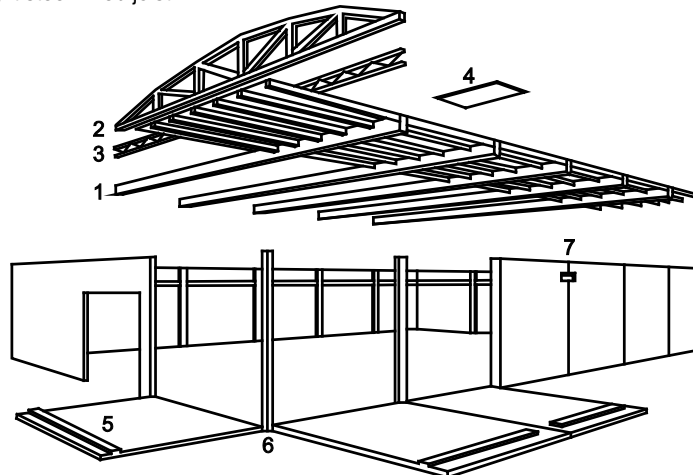

Details:

5. anchor bolted wooden ledger for roof/floor support

Wall systems:

6. cast-in-place columns – square, “T” shape, and “H” shape
7. welded steel plate type panel connection

Figure 2. Tilt-up Construction.

(Federal Emergency Management Agency Publication FEMA 154, March 2002, Rapid Visual Screening of Buildings for Potential Seismic Hazards.)

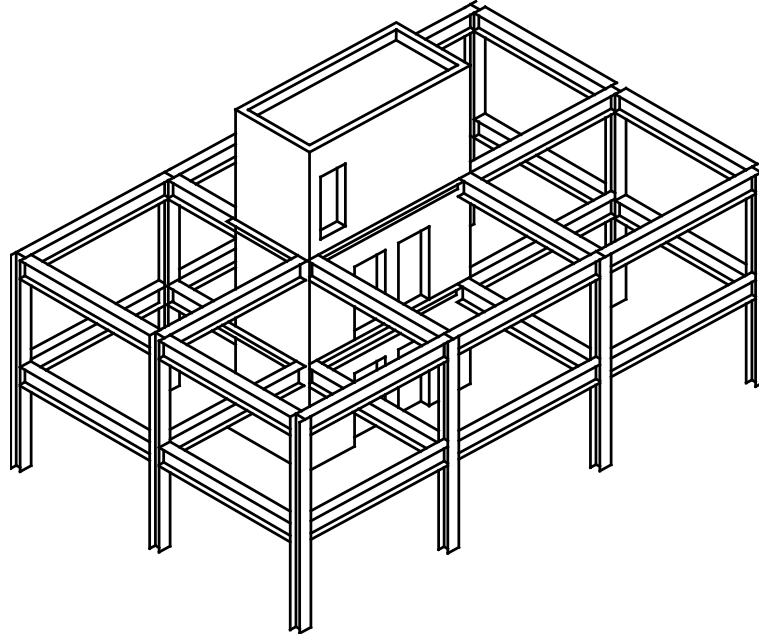

Figure 3. Steel Frame With Shear Wall.
 (Federal Emergency Management Agency Publication FEMA 154, March 2002, Rapid Visual Screening of Buildings for Potential Seismic Hazards.)

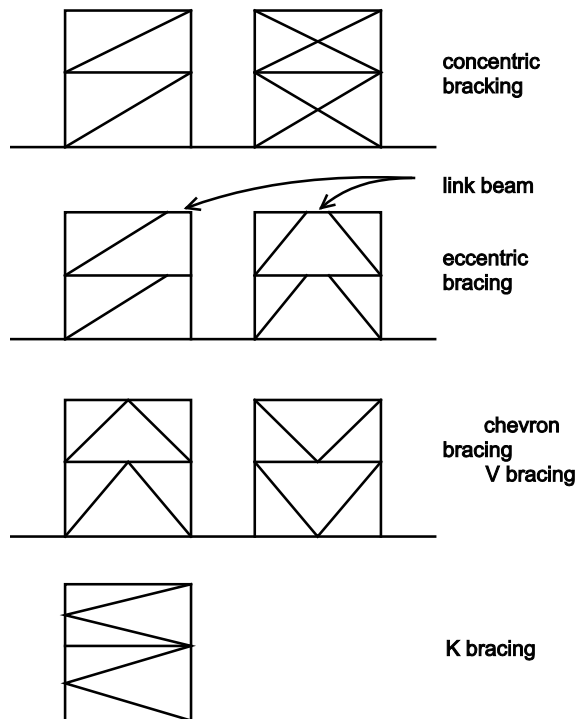

Figure 4. Bracing Types.
 Federal Emergency Management Agency Publication FEMA 547, October 2006; Techniques for Seismically Rehabilitating Existing Buildings.

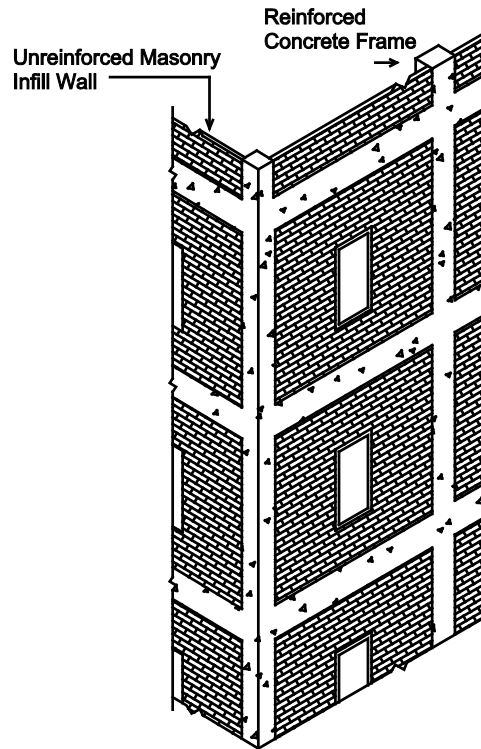

Figure 5. Concrete Frame With URM Infill.
 (Federal Emergency Management Agency Publication FEMA 154, March 2002, Rapid Visual Screening of Buildings for Potential Seismic Hazards.)

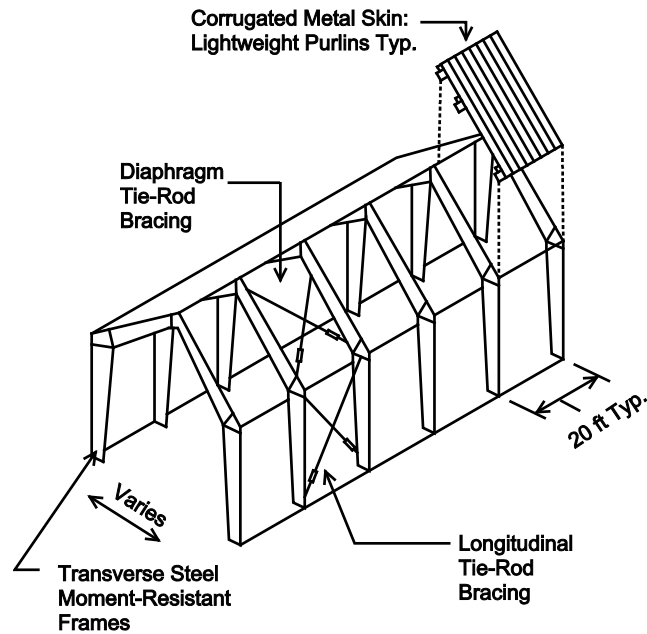
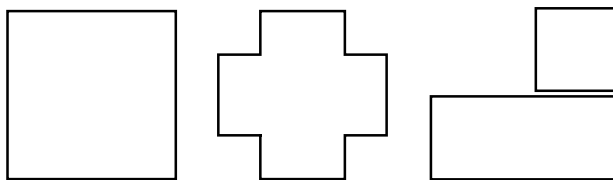
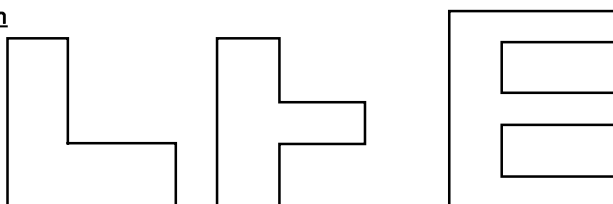

Figure 6. Light Metal Construction.
 (Federal Emergency Management Agency Publication FEMA 154, March 2002, Rapid Visual Screening of Buildings for Potential Seismic Hazards.)

Symmetry In Plan



Asymmetry In Plan



Irregularity In Elevation

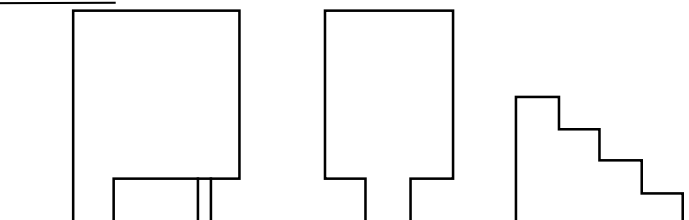

Figure 7. Building Configuration: Symmetry, Asymmetry, And Irregularity.
 (Federal Emergency Management Agency Publication FEMA 154, March 2002, *Rapid Visual Screening of Buildings for Potential Seismic Hazards.*)

REFERENCES

- ASCE 7, *Minimum Design Loads For Buildings And Other Structures*, American Society of Civil Engineers, Reston, VA.
 AS 1170.4 *Structural Design Actions Part 4: Earthquake Loads*, Standards Australia, Sydney, Australia – Australia
 NZS 1170 *Part 5: Earthquake Actions*, Council of Standards New Zealand
 EN 1998-1 – *Design of Structures for Earthquake Resistance-Part 1: General Rules, Seismic Actions And Rules For Buildings*, European Committee For Standardization, Brussels, Belgium – Europe
 GB50011 *Code for Seismic Design of Buildings*, China Architecture and Building Press, Baiwanzhuang, Beijing, China
 IS:1893 *Indian Standards Criteria for Earthquake Resistant Design of Structures*, Bureau of Indian Standards, New Delhi, India
 AIJ-RLB - *Recommendations For Loads On Buildings*, Architectural Institute of Japan, Tokyo, Japan
 NBCC - *National Building Code of Canada*, National Research Council of Canada, Ottawa, Canada